

DELTA-U GOOT 500x500 SERIE B000 TYPE I

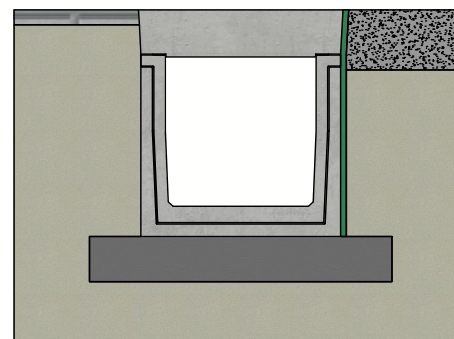

Principe type I
(Raadpleeg de plaatsingsvoorschriften)

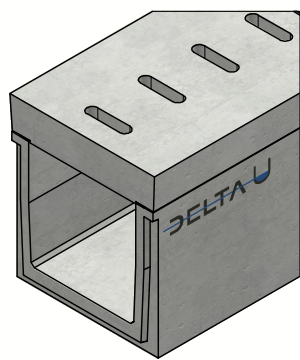
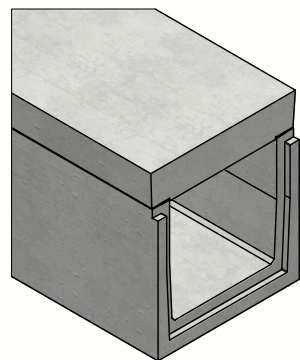

Belastingsklasse:	D400 cf EN1433
Instroomoppervlak cm ² / lm:	N/A
Sleufprofieltype:	N/A
Randen:	geen
Sectie stroomprofiel cm ² :	2500
Betonsterkteklasse:	C60/75
Omgevingsklassen:	XD3-XF4-XC4-XA3
Duurzaamheid:	W+R
Werkende lengte:	2000
Helling stroomprofiel:	0
Helling bovenvlak:	N/A
Verbinding:	T/G tand/groef
Hijsvoorziening:	4 x DH 1,3T
Plaatsingsvoorschrift:	volgens opgave producent
Normering:	getest volgens EN1433
Gewicht:	1236 Kg

DELTA U

B.P.M.N. SA
Chaussée de namur 2, B-5150 Floriffoux

Project :	Technische fiche	
Art. nr. :	DELTA-U5005002000B000D	
REV. nr. :	0	REV. Datum : 30/03/2023



DELTA-U GOOT 500x500 SERIE B000 TYPE I

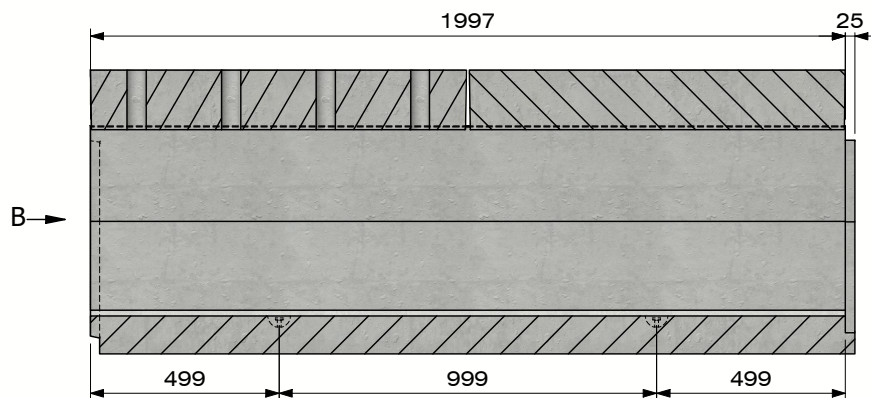

Sectie A-A
(Schaal 1 : 20)

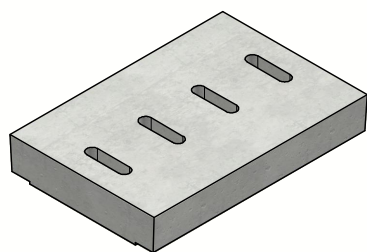
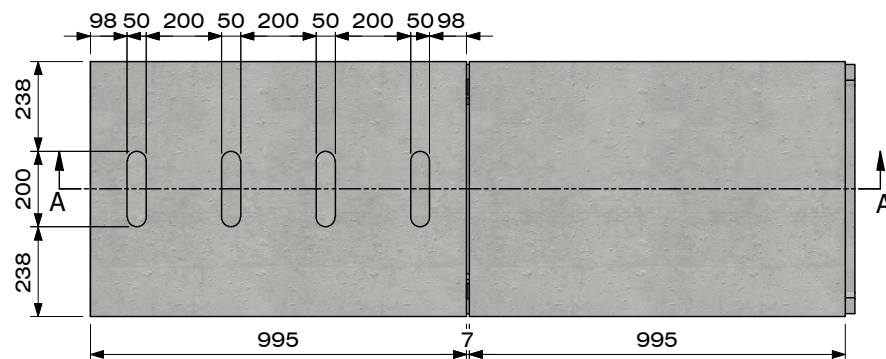

Dekplaat
met openingen

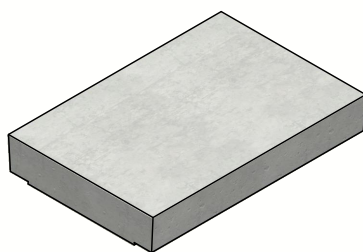

Dekplaat
zonder openingen

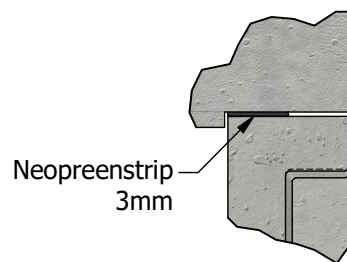

Detail D

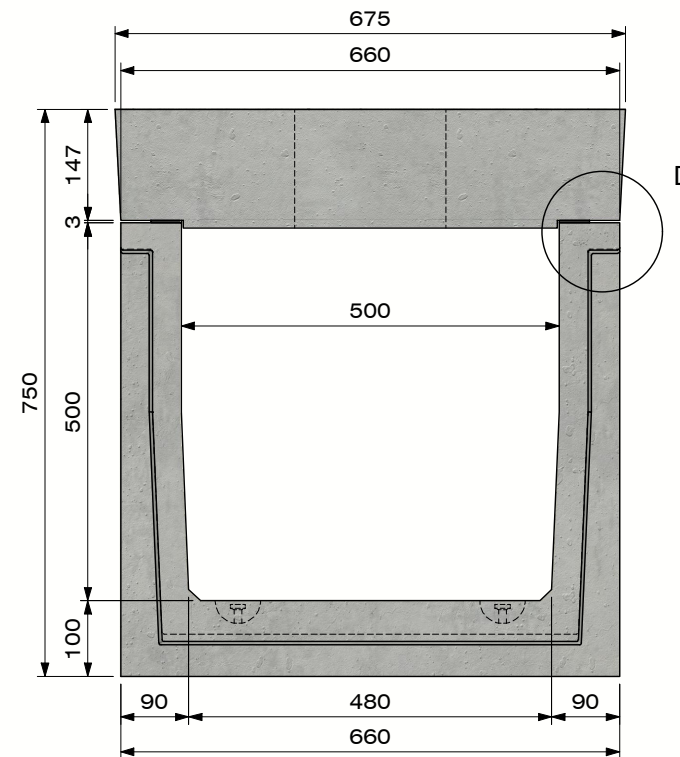

Zicht B



B.P.M.N. SA
Chaussée de namur 2, B-5150 Floriffoux

Project :	Technische fiche		
Art. nr. :	DELTA-U5005002000B000D		
REV. nr. :	0	REV. Datum :	30/03/2023

